

Installation Manual

JEEP RENEGADE 5DR
JEE-RENE-5-A



COMPONENTS INCLUDED

SHADES

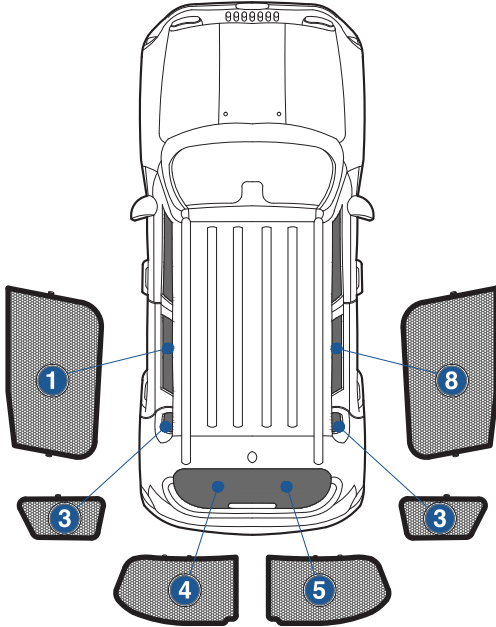

FIXING CLIPS



CL-M02 x 4



CL-M12 x 2



CL-M05 x 2



CL-M01 x 2



CL-M14 x 1



CL-T01 x 1

Side Shade Installation

JEEP RENEGADE 5DR
JEE-RENE-5-A

COMPONENTS NEEDED:



STEP #1

INSERT CLIPS INSIDE WEATHERSTRIP



STEP #2

ATTACH CLIPS ON SHADE EDGES



STEP #3

POSITION THE SIDE SHADE



STEP #4

ATTACH SIDE SHADE BEHIND CLIPS

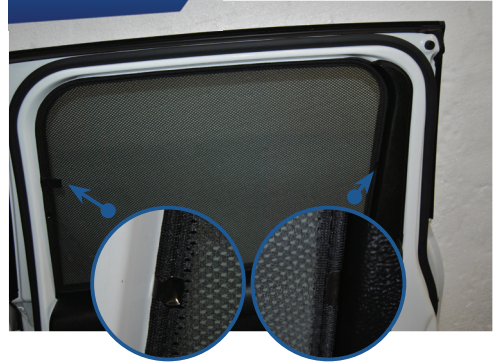

STEP #5

ENSURE SECURELY FITTED IN PLACE



CAR SHADES

Quarter Light Shade Installation

JEEP RENEGADE 5DR
JEE-RENE-5-A

COMPONENTS NEEDED:



STEP #1

ATTACH CLIPS ON SHADE EDGES



STEP #2

INSERT CLIPS BEHIND INTERIOR TRIM



STEP #3

ENSURE SECURELY FITTED IN PLACE

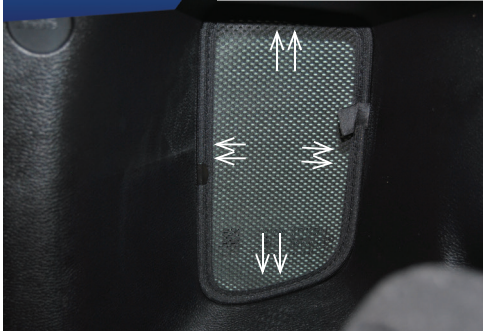

Rear Shade Installation

JEEP RENEGADE 5DR
JEE-RENE-5-A

COMPONENTS NEEDED:

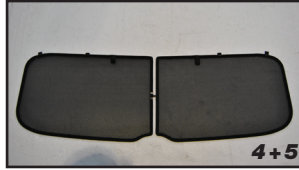

STEP #1

ATTACH CLIPS ON SHADE EDGES



STEP #2

POSITION THE REAR SHADE

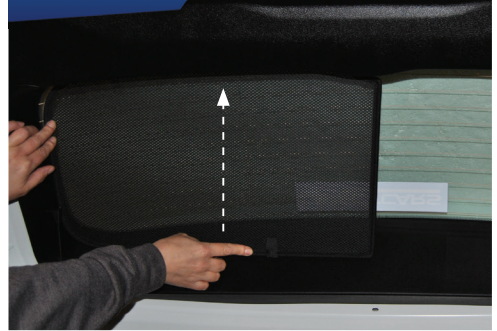

STEP #3

INSERT CLIPS BEHIND INTERIOR TRIM

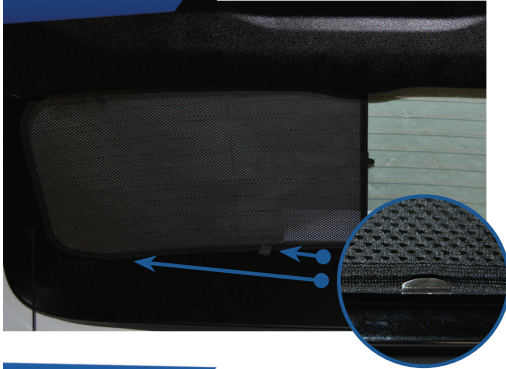

STEP #4

REPEAT THE PROCESS ON OTHER SHADE



STEP #5

ENSURE SECURELY FITTED IN PLACE

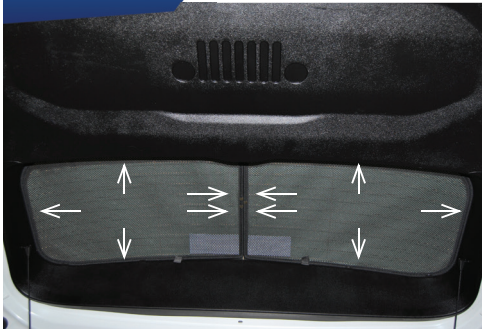

CAR
SHADES