

FIT KIT

K

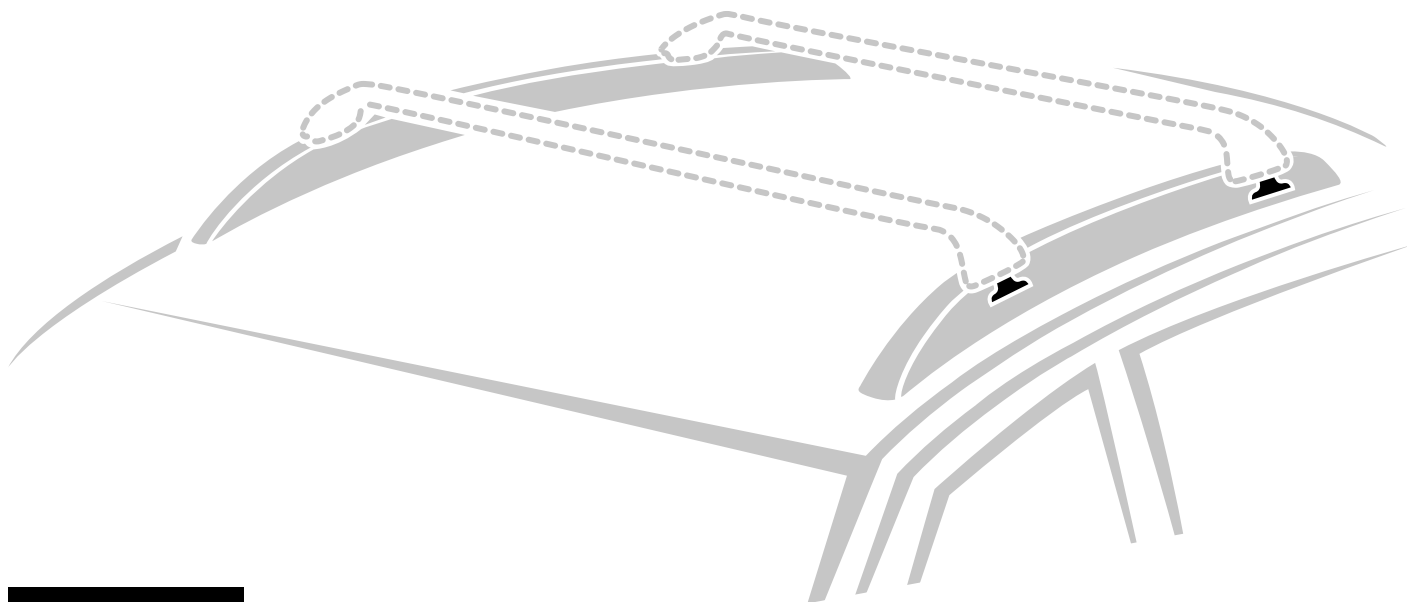

N21418

K8

91CA0185 r02



Max
75 Kg.



- | | | | |
|-------------------------------------|--|---------------------------------------|-----------------------------------|
| (I) Istruzioni di montaggio | (NL) Montage-instructies | (PL) Instrukcja montażu | (H) A felszerelés módja |
| (EN) Fitting instructions | (S) Monteringsanvisning | (RUS) Инструкции по установке | (GR) Οδηγία συναρμολόγησης |
| (F) Instructions de montage | (FIN) Asennusohje | (CZ) Návod na montáž | (TR) Montaj talimatları |
| (D) Montageanleitung | (EST) Paigaldusjuhend | (SK) Návod na montáž | (BG) Инструкции за монтаж |
| (E) Instrucciones de montaje | (LAT) Stiprināšanas instrukcija | (SLO) Navodila za pritrjevanje | (SRB) Uputstva za montažu |
| (P) Instruções de montagem | (LT) Pritvirtinimo instrukcijos | (HR) Uputa za sastavljanje | |

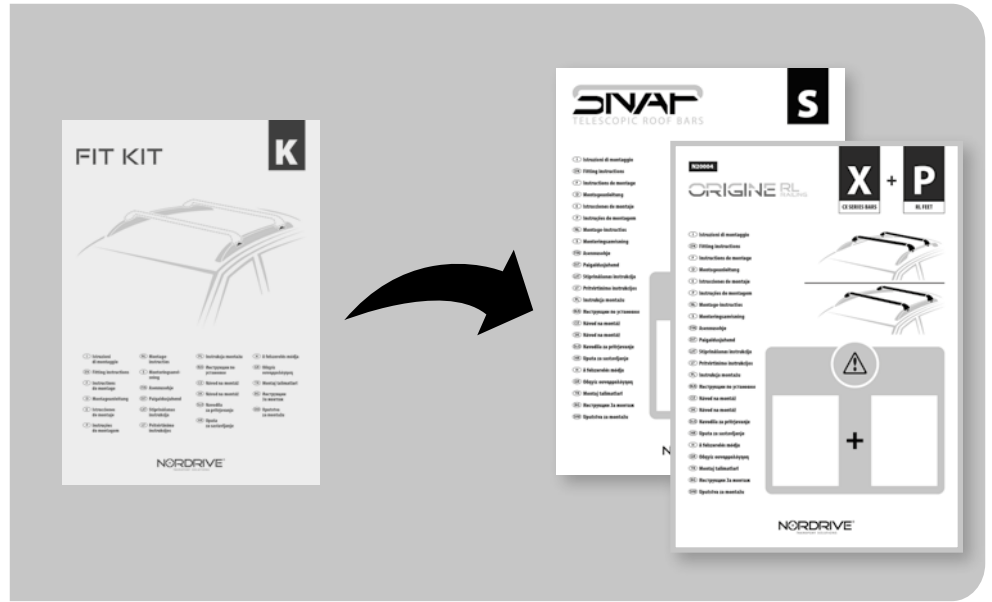

- I** Iniziare dal manuale **S** oppure **X+P**, prima di proseguire con queste istruzioni.
- EN** Before following these instructions **S** or **X+P** please start firstly the manual.
- F** Avant de suivre ces instructions **S** ou **X+P**, veuillez commencer par le manuel.
- D** Lesen Sie zuerst die Anleitung von **S** oder **X+P**, bevor Sie die folgende Anweisung weiterlesen.
- E** Inicie desde el manual de **S** o **X+P**, antes de continuar con estas instrucciones.
- P** Antes de seguir estas instruções **S** ou **X+P**, leia o manual.
- NL** Voordat u deze instructies **S** of **X+P**, volgt, dient u eerst de handleiding te starten.
- S** Innan ni följer dessa instruktioner **S** eller **X+P**, vänligen läs manualen.
- FIN** Aloita **S** tai **X+P** -oppaasta, ennen kuin jatkat näiden ohjeiden noudattamista.
- EST** Enne nende juhiste **S** või **X+P**, järgimist alustage kõigepealt kasutusjuhendit.
- LAT** Pirms izpildāt šos norādījumus **S** vai **X+P**, lūdzu, vispirms sāciet rokasgrāmatu.
- LT** Prieš pradėdant sekti šias instrukcijas **S** arba **X+P**, prašome perskaityti vadovą.

- PL** Przed wykonaniem tych instrukcji **S** lub **X+P** należy najpierw zapoznać się z instrukcją.
- RUS** Прежде чем приступить к выполнению этих инструкций **S** или **X+P**, начните с руководства.
- CZ** Než budete pokračovat v těchto pokynech **S** nebo **X+P**, začněte od manuálu.
- SK** Predtým ako budete postupovať podľa návodu **S** alebo **X+P**, prosím prečítajte návod.
- SLO** Pred vykonaním týchto pokynov **S** oz **X+P** najskôr spustite príručku.
- HR** Prije upotrebe ovih uputa **S** ili **X+P**, prvo pokrenite priručnik.
- H** Mielőtt követné ezt az utasítást **S** vagy **X+P**, olvassa el az használati útmutatóját.
- GR** Διαβάστε τις οδηγίες του **S** ή **X+P** προτού ακολουθήσετε αυτές τις οδηγίες.
- TR** Bu talimatları uygulamadan önce, lütfen öncelikle **S** veya **X+P** kılavuzunu başlatın.
- BG** Преди да следвате тези инструкции, прочетете ръководството на **S** или **X+P**.
- SRB** Pre nego što sledite ova uputstva, molimo vas pročitajte priručnik **S** или **X+P**.



N21418 - K8 FIT KIT

Contenuto • Content • Contenu • Inhalt • Contenido

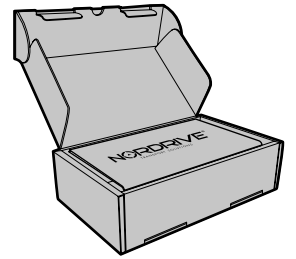

CLAMP KIT

x2

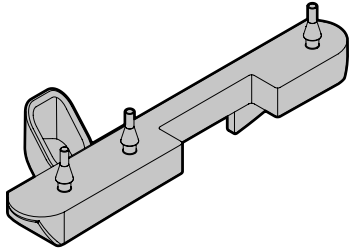

00GO0186

x2

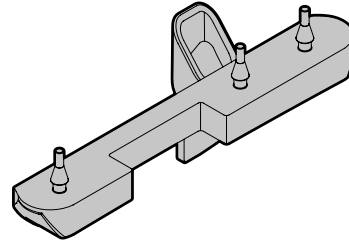

00GO0187

x4

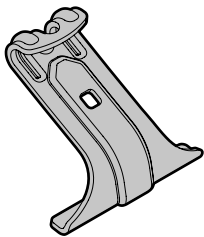

40FE0167

x4

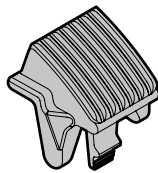

30NA0004

x4

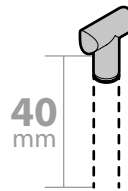

40
mm

M6x40

x4

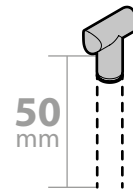

50
mm

M6x50

x4

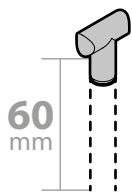

60
mm

M6x60

x4

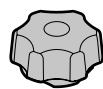

84FE0001

SNAP
— STEEL —

Art. N15010 **S** 5,5Kg.

Art. N15012 **L** 6,3Kg.

SNAP
STEEL RAIL

Art. N15014 **S** 5,8Kg.

Art. N15016 **L** 6,6Kg.

SNAP
— ALU —

Art. N15011 **S** 3,4Kg.

Art. N15013 **L** 3,8Kg.

SNAP
ALU RAIL

Art. N15015 **S** 3,7Kg.

Art. N15017 **L** 4,1Kg.

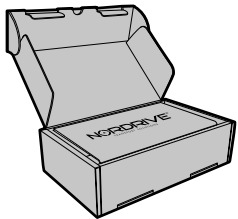

+

K8

0,6Kg.

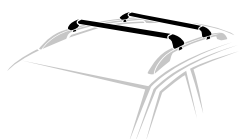
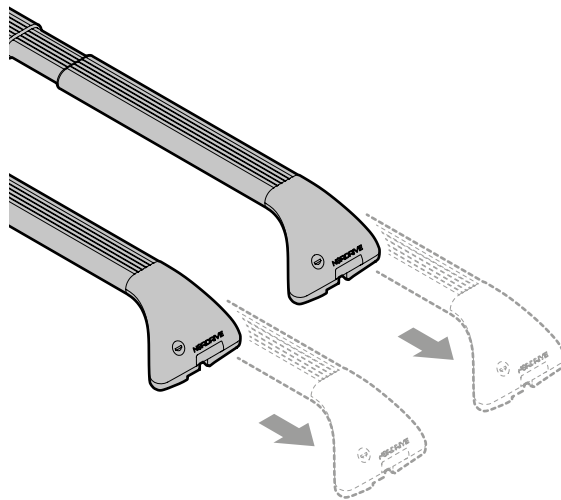
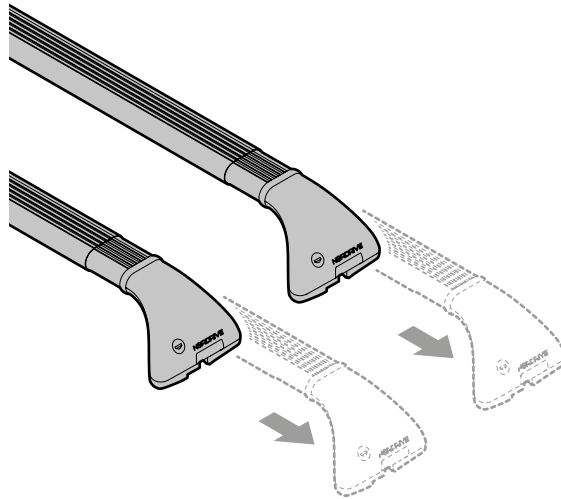

+



+



=

Max
75 Kg.



max
kg. ??

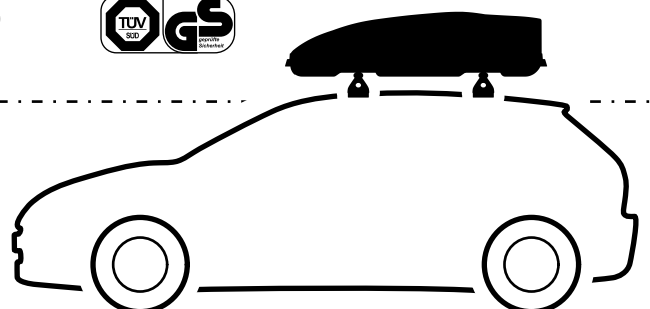



2.1

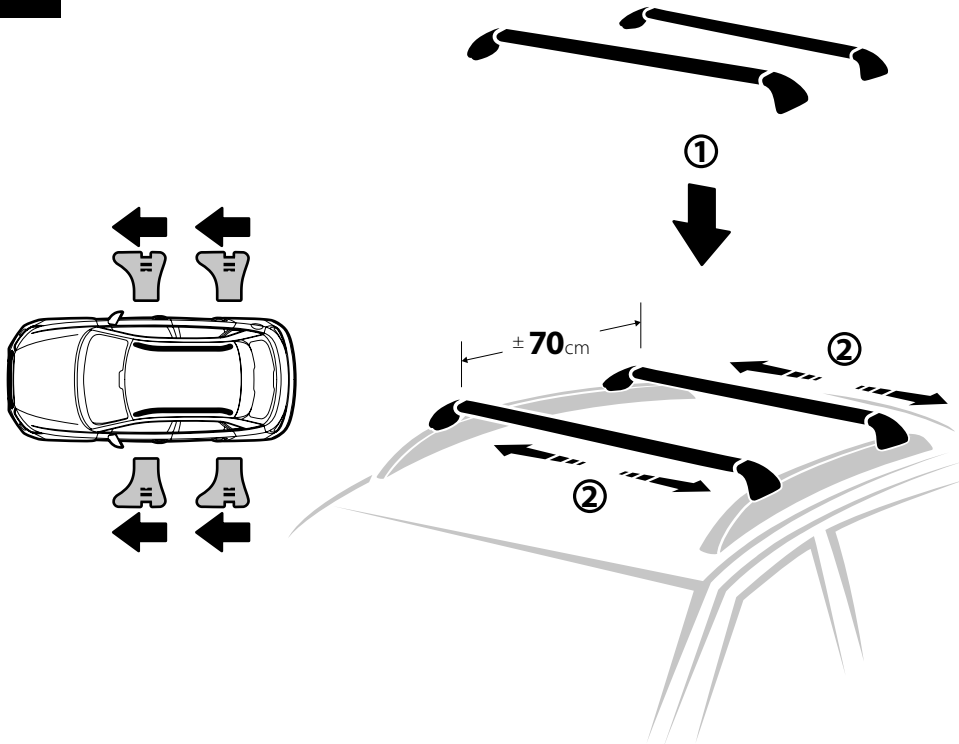

OK



NO

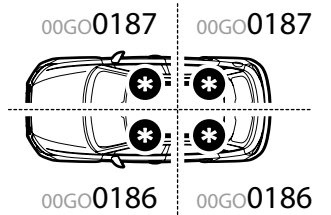
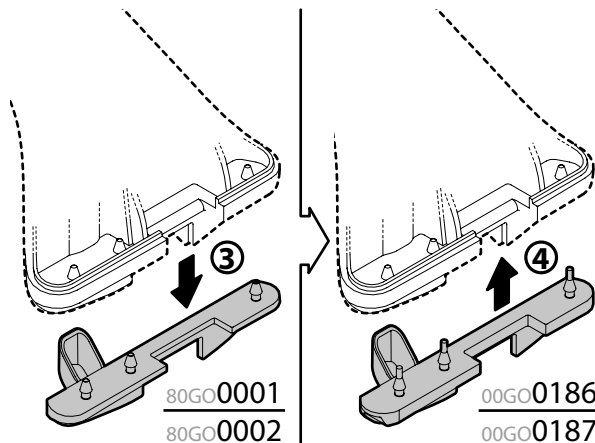
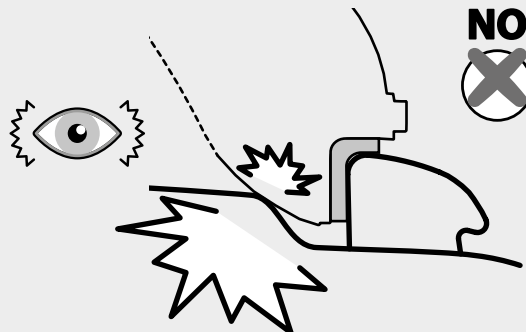
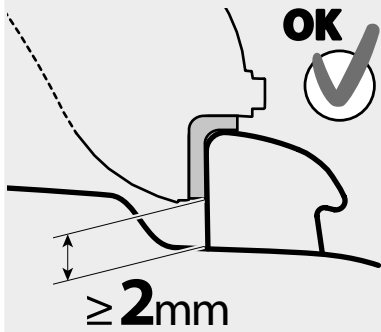

2.3

- Ⓘ Per Ⓓ Für
- Ⓢ For Ⓔ Para
- Ⓕ Pour

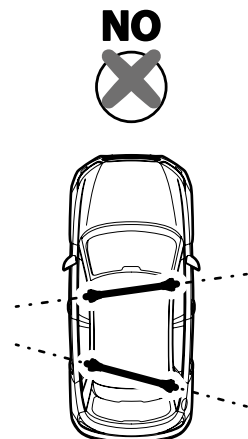
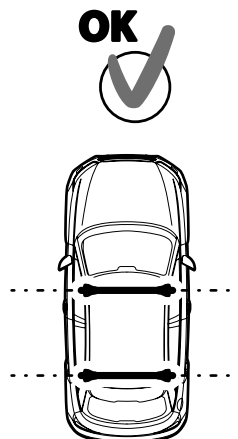
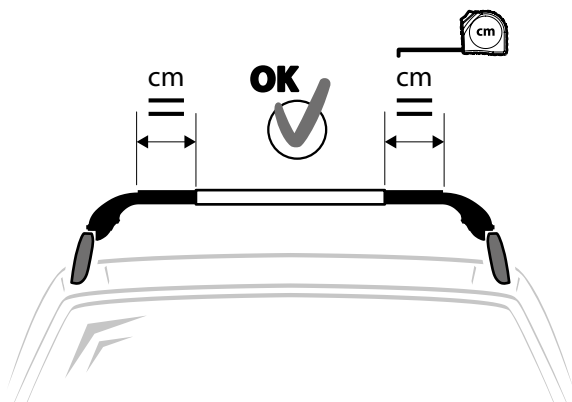

2.4

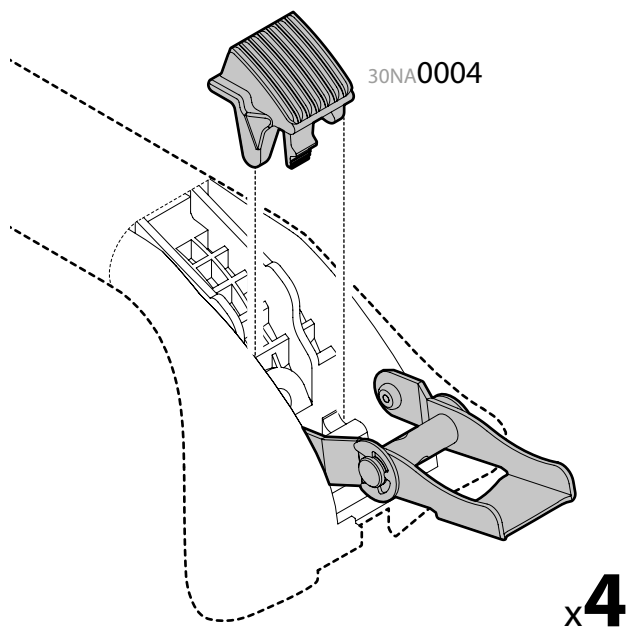
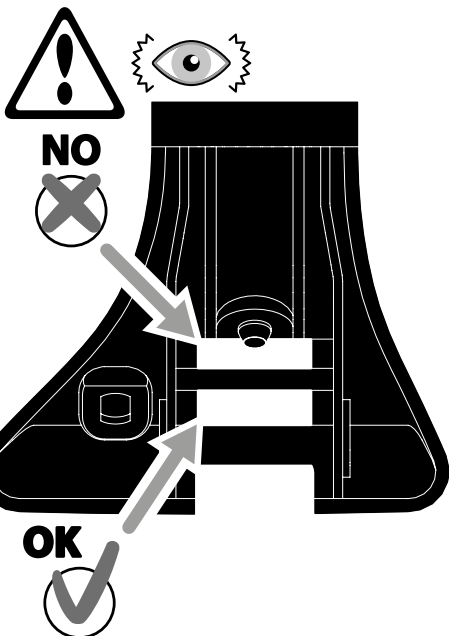

2.5

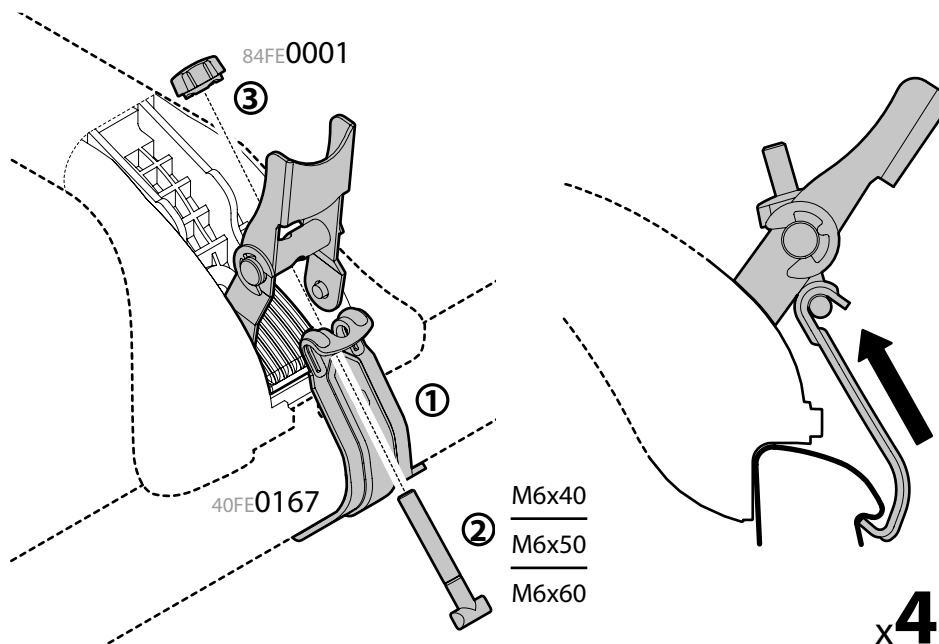
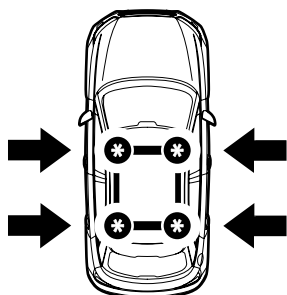

2.6

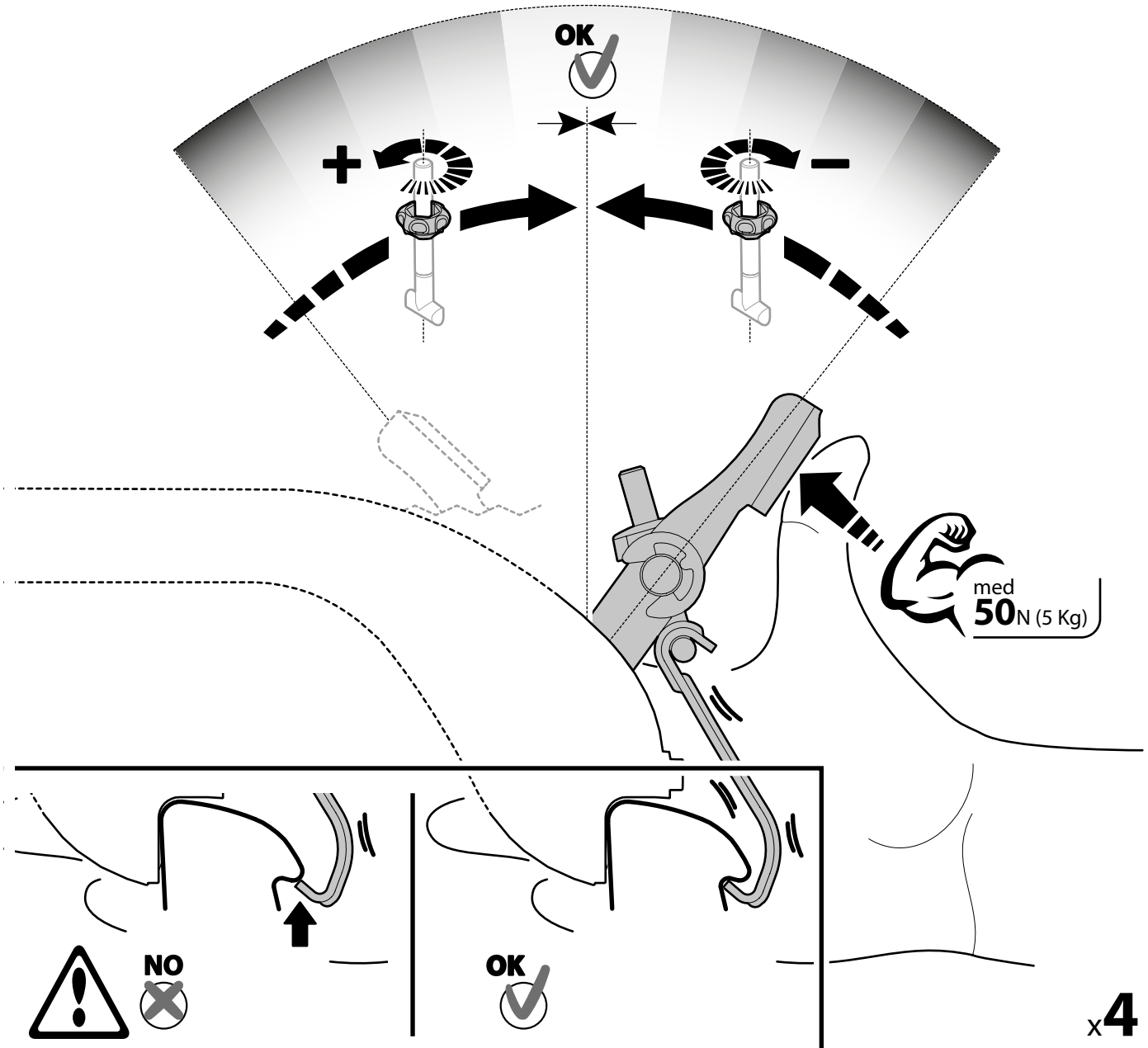

2.7

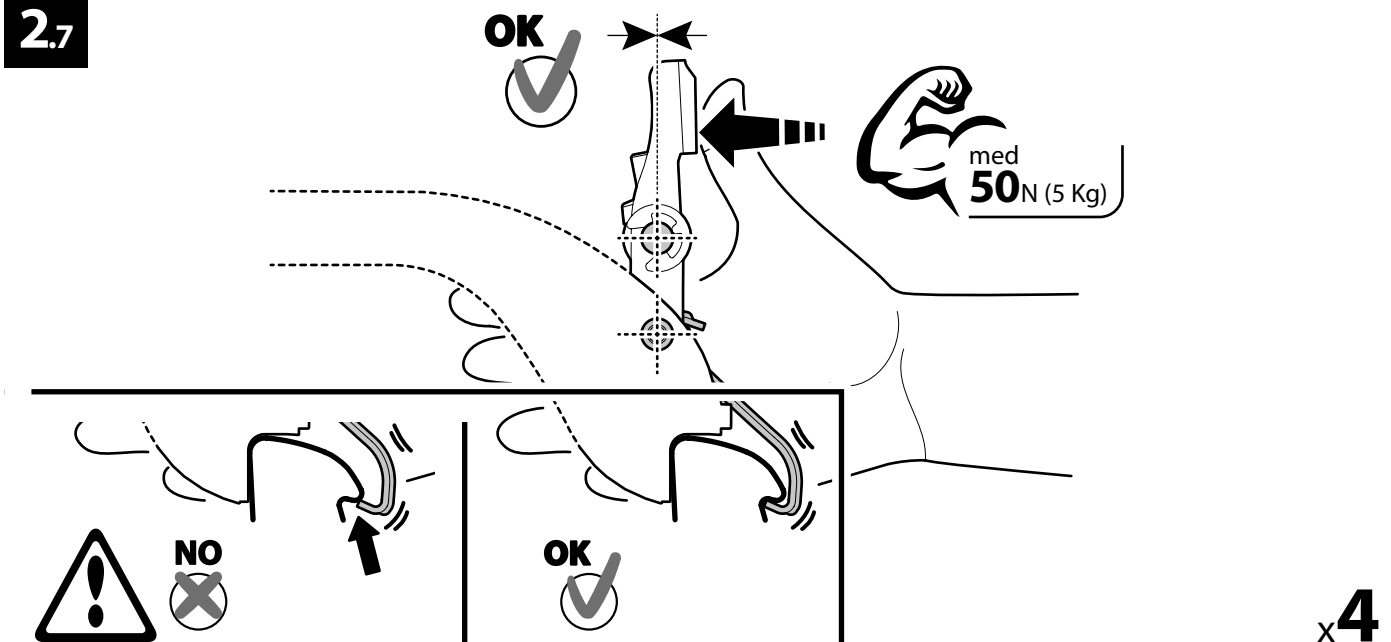

2.8

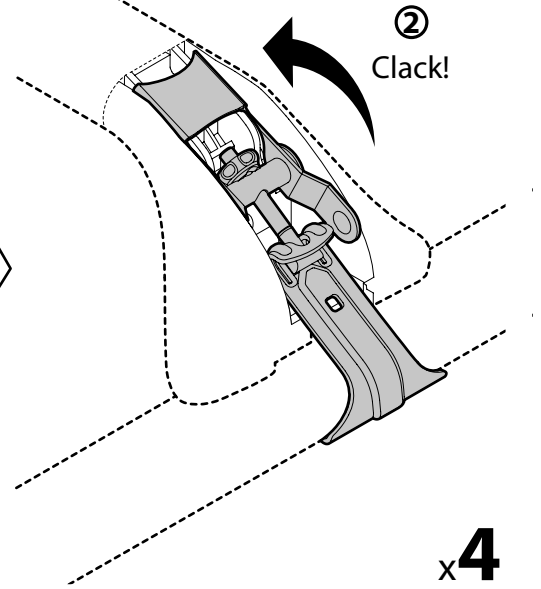
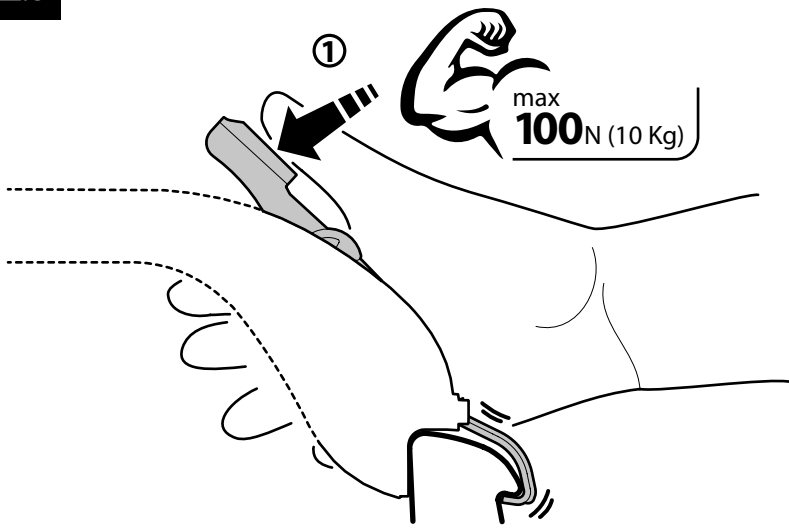

Attenzione • Warning • Attention • Hinweise • Advertencia

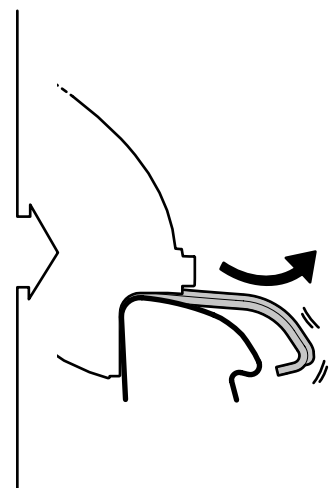
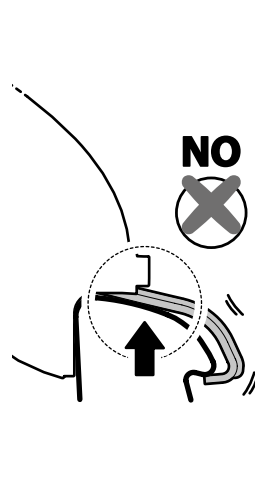
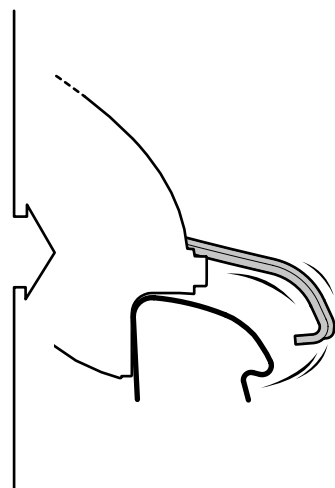
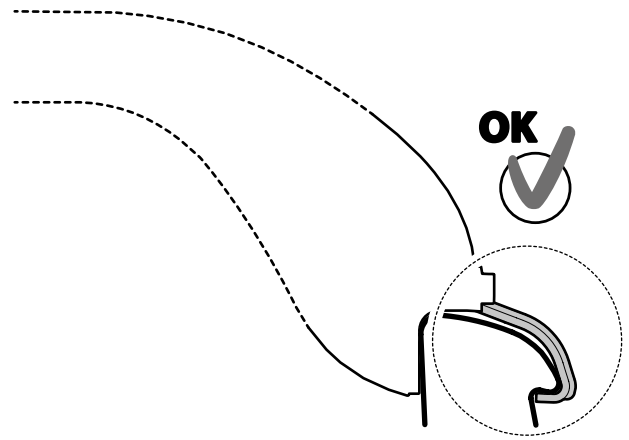
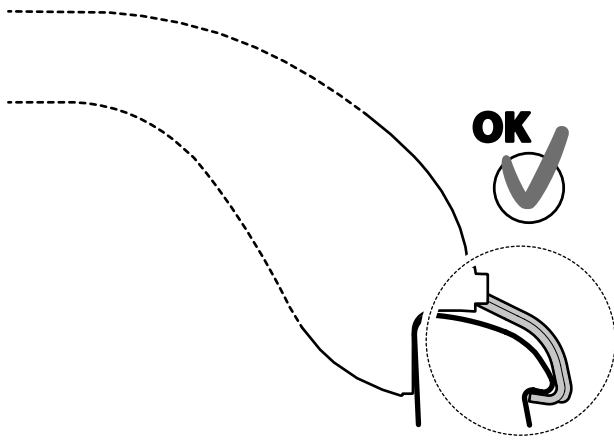



Attenzione • Warning • Attention • Hinweise • Advertencia

0100 Km

Pit-stop / Check!

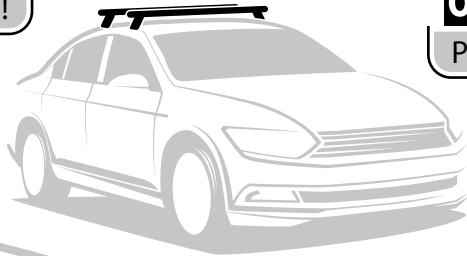

0250 Km

Pit-stop / Check!



0500 Km

Pit-stop / Check!



Pit-stop / Check!

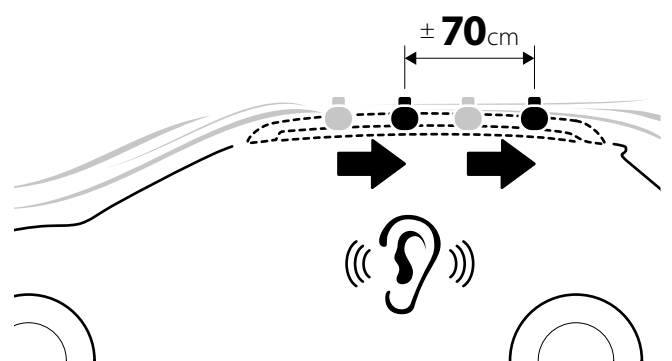
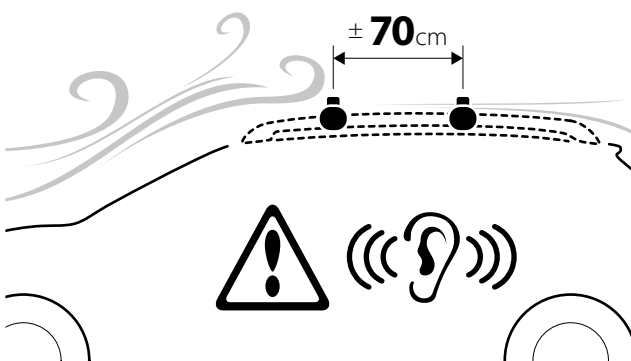
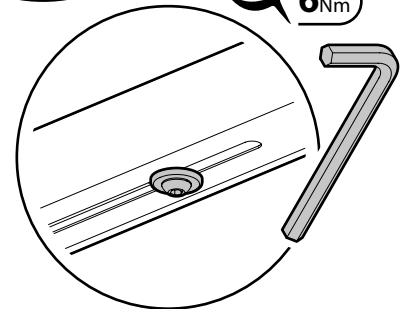
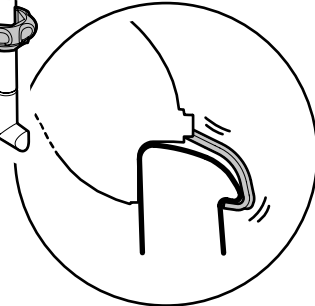
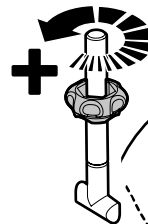
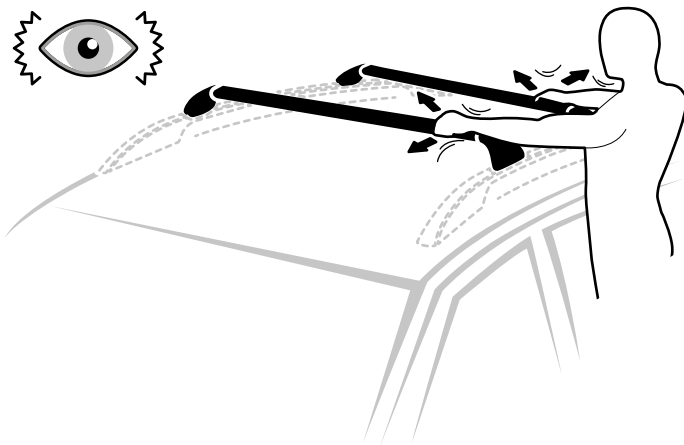

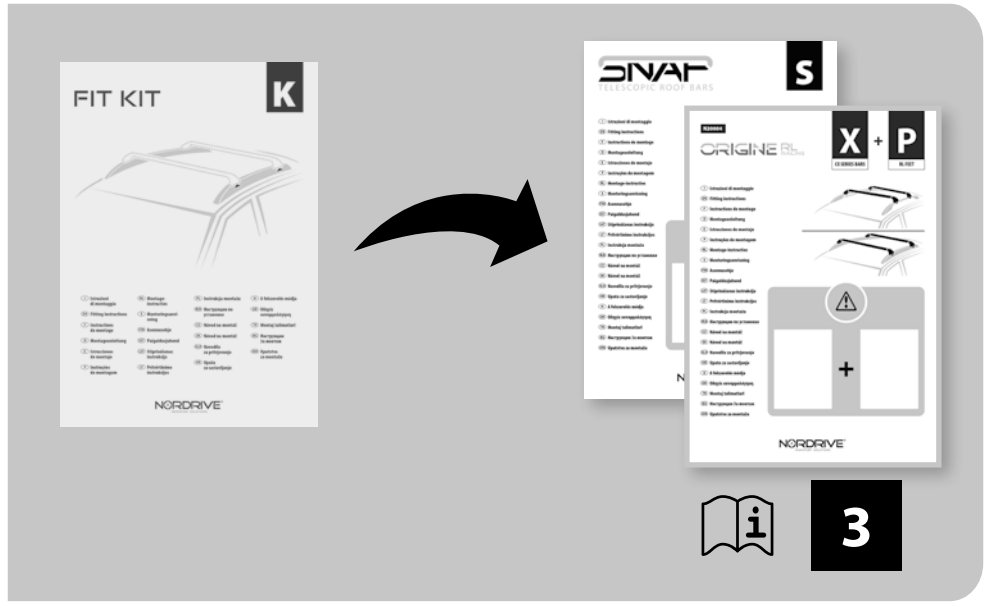

- I** Passare al manuale **S** oppure **X+P** e seguire le istruzioni come indicato ad intestazione pagina.
- EN** Switch to manual **S** or **X+P** and then follow the instructions as indicated above.
- F** Passez au manuel **S** ou **X+P** et suivez les instructions comme indiqué ci-dessus.
- D** Das Handbuch **S** oder **X+P** konsultieren und die Anleitungen wie angegeben auf Kopfzeile der Seite folgen.
- E** Vaya al manual de **S** o **X+P** y siga las instrucciones que se indican en el encabezado de la página.
- P** Passe para o manual **S** ou **X+P** e siga as instruções indicadas acima.
- NL** Schakel over op manuele **S** of **X+P** en volg dan de instructies zoals hierboven aangegeven.
- S** Byt till manual **S** eller **X+P** och följ där instruktionerna enligt ovan.
- FIN** Vaihda manuaaliseen **S** tai **X+P** -sarjaan ja noudata sitten yllä olevia ohjeita.
- EST** Avage **S** või **X+P** juhend ja järgige ülal toodud juhiseid.
- LAT** Pārslēdzieties uz manuālo **S** vai **X+P** un pēc tam izpildiet norādījumus, kā norādīts iepriekš.
- LT** Pereikite į vadovą **S** arba **X+P** ir tuomet sekite instrukcijas kaip nurodyta aukščiau.

- PL** Przełącz na ręczny **S** lub **X+P**, a następnie postępuj zgodnie z instrukcjami, jak wskazano powyżej.
- RUS** Перейдите к руководству по **S** или **X+P** и следуйте инструкциям, указанным в заголовке страницы.
- CZ** Přejděte do příručky **S** nebo **X+P** a postupujte podle pokynů uvedených v záhlaví stránky.
- SK** Prejdite na návod **S** alebo **X+P** a postupujte podľa pokynov uvedených vyššie.
- SLO** Zamenjajte na navodila **S** oz **X+P** n potem jim sledite kot je navedeno zgoraj.
- HR** Prebacite se na priručnik **S** ili **X+P** i zatim slijedite gore navedene upute.
- H** Váltson át az **S** vagy **X+P** használati útmutatójára és kövesse a fenti utasításokat.
- GR** Μεταβείτε στο φυλλάδιο του **S** ή **X+P** και κατόπιν ακολουθήστε τις οδηγίες που φαίνονται παραπάνω.
- TR** Manuel **S** veya **X+P**'ye geçin ve ardından yukarıda belirtilen talimatları izleyin.
- BG** Преминете към ръководството **S** или **X+P** и след това следвайте инструкциите по-горе.
- SRB** Pređite na priručnik **S** или **X+P** a zatim sledite gore navedena uputstva.

- ① Lotto di produzione da comunicare per eventuali ricambi
- Ⓞ Production lot number to be communicated for any spare parts
- ⓕ Lot de production à communiquer pour toute pièce de rechange
- ⓓ Produktionscharge für eventuelle Ersatzteile
- ⓔ Lote de producción a comunicar por cualquier repuesto

Lot.

NORDRIVE[®]
TRANSPORT SOLUTIONS

**NORDRIVE[®] is a registered trademark of
LAMPA S.p.A.**

Via G. Rossa 53/55, 46019 Viadana (MN) ITALY
Tel. +39 0375 820700

UNI EN ISO 9001:2015 Certified Company
service@lampa.it

www.nordrive.it www.lampa.it